

## DIN Rail Mount 17.5 mm MUR4 Part number 88826100

DIN Rail Mount 17.5 mm MUR4 Part number 88826100

Just one digit differentiates the new range part number from the old range's  
Previous part number : 88 826 XXX / new part number : 88 827 XXX

### Part numbers

	Type	Functions	Timing	Output	Nominal rating	Connections	Supply voltage
88 826 100	MUR4	A - At - B - C - H - Ht - Di - D - Ac - Bw	0,1s→100h	1 changeover relay	8 A	Screw terminals	12 V AC / DC

### Specifications

#### Timing

Timing ranges (7 ranges)	1 s - 10 s - 1 min - 10 min - 1 h - 10 h - 100 h TK2R1 : 0.6s - 2.5s - 20s - 160 s
Repetition accuracy with constant parameters	± 0.5 % (IEC/EN 1812-1)
Drift Temperature	± 0,05 % / °C
Drift Voltage	± 0.2 % / V
Display accuracy according to IEC/EN 61812-1	± 10 % / 25 °C
Minimum pulse duration typically (relay version)	30 ms
Minimum pulse duration typically (solid state version)	50 ms
Minimum pulse duration typically (relay version under load)	100 ms
Maximum reset time by de-energisation typically (relay version)	100 ms
Maximum reset time by de-energisation typically (solid state version)	350 ms
Immunity from micro power cuts : typical	> 10 ms
<b>Supply</b>	
Multi-voltage power supply	Depending on version
Frequency (Hz)	50 / 60
Operating range	85 to 110 % Un (85 to 120 % Un for 12V AC/DC)
Operating factor	100 %
Max. absorbed power	0,6 W 24 V AC/DC 1,5 W 230 V AC 32 VA 230 V AC

#### Output specification

1 or 2 changeover relays, AgNi (cadmium-free)	2000 VA/80 W
Rated power	2000 VA/80 W
Maximum breaking current	8 A AC 8A DC
Minimum breaking current	10 mA / 5 V DC
Voltage breaking capacity	250 V AC/ DC
Electrical life (operations)	10 <sup>5</sup> operations 8 A 250 V resistive
Mechanical life (operations)	5x10 <sup>6</sup>
Breakdown voltage acc. to IEC/EN 61812-1	2.5 kV / 1 min / 1 mA / 50 Hz
Impulse voltage acc. to IEC/EN 60664-1, IEC/EN 61812-1	5 kV, wave 1.2 / 50 µs

#### Solid state output

Rated power	0,7 A AC/DC 20 °C (0,5 A UL)
Derating	5 mA / °C
Maximum admissible current	20 A ≤ 10 ms
Minimum breaking current	10 mA
Leakage current	< 5 mA
Voltage breaking capacity	250 V AC/ DC
Maximum voltage drop at terminals	3 wire 4V - 2 wire 8V
Electrical life (operations)	10 <sup>8</sup>
Mechanical life (operations)	10 <sup>8</sup>
Breakdown voltage acc. to IEC/EN 60664-1, IEC/EN 60255-5	2.5 kV to 1 mA / 1 min
Input type	Volt-free contact 3-wire PNP output control option residual voltage : 0.4V whatever the timer power supply

#### General characteristics

Conformity to standards	IEC/EN 61812-1 IEC/EN 61000-6-1 IEC/EN 61000-6-2 IEC/EN 61000-6-3 IEC/EN 61000-6-4
Certifications	CE, UL, cUL, CSA, GL

Temperature limits use (°C)	-20 → +60
Temperature limits stored (°C)	-30 → +60
Installation category (acc. to IEC/EN 60664-1)	Voltage surge category
Creepage distance and clearance acc. to IEC/EN 60664-1	4 kV / 3
Protection (IEC/EN 60529)	IP 20 IP 40
Degree of protection acc. to IEC/EN 60529 Front face (except Tk2R1)	IP 50
Vibration resistance acc. to IEC/EN 60068-2-6	f = 10 ■ 55 Hz A = 0,35 mm
Relative humidity no condensation acc. to IEC/EN 60068-2-30	93 % sans condensation
Electromagnetic compatibility - Immunity to electrostatic discharges acc to IEC/EN 61000-4-2	Level III (Air 8 kV / Contact 6 kV)
Immunity to radiated, radio-frequency, electromagnetic field acc. IEC/EN 61000-4-3	Level III 10V/m (80 M Hz to 1 G Hz)
Immunity to rapid transient bursts acc. to IEC/EN 61000-4-4	Level III (direct 2kV / Capacitive coupling clamp 1 kV)
Immunity to shock waves on power supply acc. to IEC/EN 61000-4-5	Level III (2 kV / common mode 2 kV/residual current mode 1 kV)
Immunity to radio frequency in common mode acc. to IEC/EN 61000-4-6	Level III (10V rms : 0.15 M Hz to 80 M Hz)
Immunity to voltage dips and breaks acc. to IEC/EN 61000-4-11	30 %/10 ms 60 %/100 ms > 95 %/5 s
Mains-borne and radiated emissions acc. to EN 55022 (CISPR22), EN55011 (CISPR11)	Class B
Fixing : Symmetrical DIN rail	35 mm
Connection capacity - without ferrule	2 x 2,5 mm <sup>2</sup>
Connection capacity - with ferrule	2 x 1,5 mm <sup>2</sup>
Spring terminals, 2 terminals per connection point - flexible wire	1,5 mm <sup>2</sup>
Spring terminals, 2 terminals per connection point - rigid wire	2,5 mm <sup>2</sup>
Housing material	Self-extinguishing
Weight : casing 17,5 mm	60 g
Weight : casing 22,5 mm	90 g
Weight : plug-in casing	80 g

60

### Display

Visualisation des états par 1 LED

- Verte clignotante sous tension

Indication du fonctionnement LED verte

Flashes brefs :

- minuterie sous tension, pas de temporisation en cours (sauf Di-D et Li-L) \*

Clignotement :

- temporisation en cours

Allumage permanent :

- relais enclenché, pas de temporisation en cours

### Dimensions (mm)

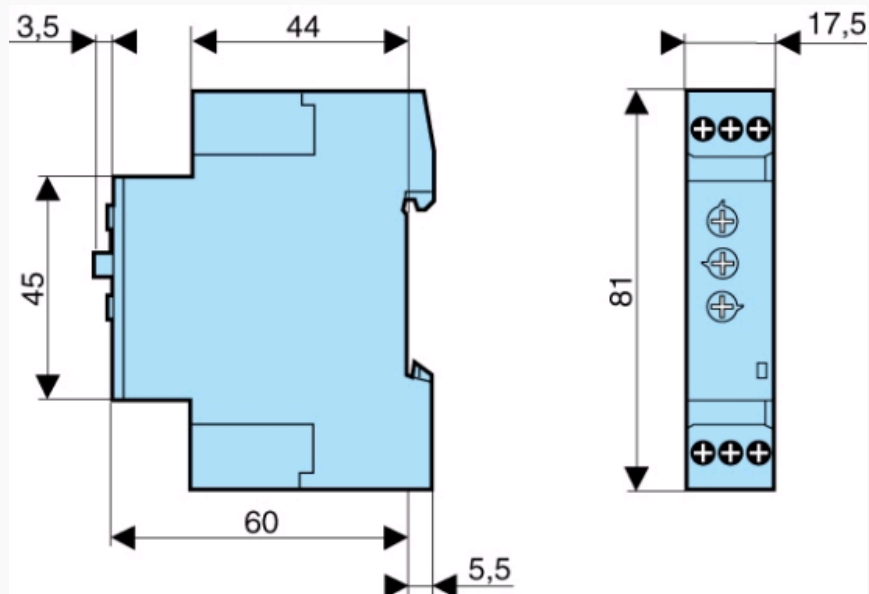

**Curves**

**Function A**

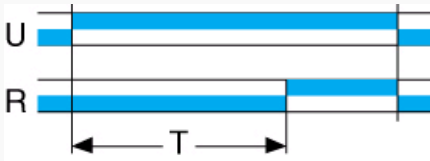

**Function A**

Delay on energisation

**Curves**

**Function Ac**



**Function Ac**

Timing after closing and opening of control contact 1 relay

**Curves**

**Function At**

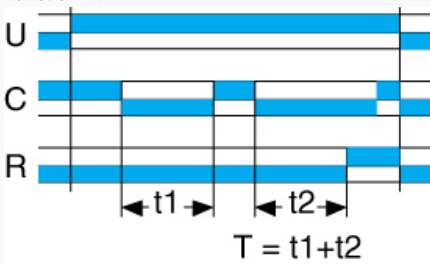

**Function At**

Timing on energisation with memory 1 relay

**Curves**

**Function B**

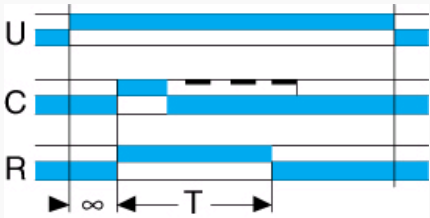

**Function B**

Timing on impulse one shot 1 relay

**Curves**

**Function Bw**

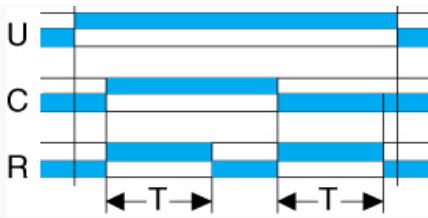

**Function Bw**  
Pulse output (adjustable) 1 relay

**Curves**

**Function C**

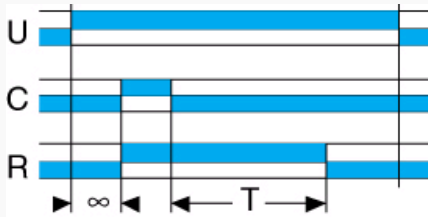

**Function C**  
Timing after impulse 1 timer

**Curves**

**Function D**

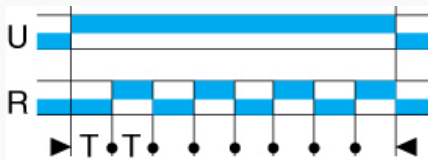

**Function D**  
Flip-flop 1 relay Pause start

**Curves**

**Function Di**

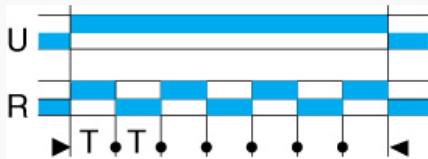

**Function Di**  
Flip-flop 1 relay Pulse start

**Curves**

**Function H**

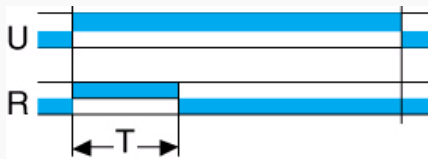

**Function H**  
Timing on energisation 1 relay

## Curves

## Function Ht

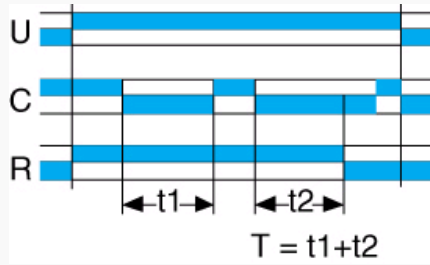

## Function Ht

Delay on energisation with memory 1 relay

## Connections

## 1 changeover relay output

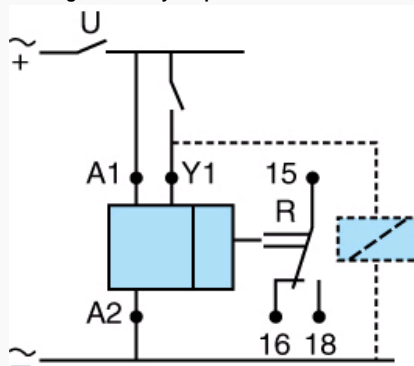

## Functions

A-At / H-Ht / B / C / Di-D / Ac / BW  
 Ad - Ah - N - O - P - Pt - Tl - Tt - W